

In-Situ® RuggedCable® Systems

Durable, Direct-Read Cable

RuggedCable Systems are custom-built to endure harsh environments and to last for years. RuggedCable Systems include:

- Titanium twist-lock connectors for quick, reliable connections to instrument body, TROLL® Com Communication Device, desiccant, and other accessories (2-year warranty)
- Metal shield beneath the cable jacket to prevent electrical interferences
- Kellems® grip for secure instrument deployment
- Small desiccant for vented systems (only for storage)

Use RuggedCable Systems with:

- Aqua TROLL® 100, 200, and 400 Instruments
- BaroTROLL® Instruments
- Con TROLL® PRO System
- Level TROLL® 300, 500, and 700 Instruments
- RDO® PRO Probe (twist-lock models)
- TROLL® 9500 Water Quality Instruments
- TROLL® Link Telemetry Systems, MultiHop Radios, and TROLL® Net Hub



Steel and plastic reels available

Customizable Cable

When ordering, consider the following options:

- **Vented or non-vented cable:** Vented cable is used with vented pressure/level sensors for gauged measurements. The cable vent tube ensures that atmospheric pressure is the reference pressure applied to the sensor diaphragm. Non-vented cable may be used with non-vented instruments for absolute measurements. Compensate absolute measurements with barometric pressure data by using a BaroTROLL® Instrument and Win-Situ® Baro Merge™ Software.
- **Jacket options:** Tefzel® (vented) or thermoplastic polyurethane (TPU; vented or non-vented)
- **Customized lengths:** Up to 1,219 m (4,000 ft)
- **Cable termination:** Twist-lock termination (female connector) on one or both cable ends. Other custom configurations are available—call for details.
- **Cable reels:** Plastic or steel reel



Extra large desiccant connected to RuggedCable System and Level TROLL Instrument



Titanium twist-lock connectors

In-Situ® RuggedCable® Systems

Specifications

Specifications	RuggedCable Systems
Operating temp. range	-25° to 80° C (-13° to 176° F)
Jacket options	<ul style="list-style-type: none"> TPU (thermoplastic polyurethane) Tefzel® (ETFE fluoropolymer; generic equivalent to Teflon®)
Vent options	<ul style="list-style-type: none"> Non-vented (absolute) Vented (gauged) with desiccant (used to mitigate moisture/humidity)
Conductors	6 conductors, 24 AWG, polypropylene insulation
Cable diameter	<ul style="list-style-type: none"> TPU: 6.7 mm (0.265 in) Tefzel: 6.35 mm (0.25 in)
Connector diameter	18.5 mm (0.73 in)
Weight	<ul style="list-style-type: none"> Non-vented, TPU: 16 kg/300 m (35.6 lbs/1,000 ft) Non-vented, Tefzel: 14 kg/300 m (32 lbs/1,000 ft) Vented, TPU: 14 kg/300 m (32 lbs/1,000 ft) Vented, Tefzel: 14 kg/300 m (32 lbs/1,000 ft)
Minimum bend radius	2X cable diameter (13.5 mm; 0.54 in)
Break strength	127 kg (280 lbs)
Maximum cable length	1,219 m (4,000 ft) for RS485
Desiccant pack (required for vented systems)	Large and extra large desiccant packs available with titanium, ABS, or stripped-and-tinned termination.
Warranty	2 years

RuggedCable Selection Guide

Application	Jacket Type	Cable Type
Aquifer characterization	TPU or Tefzel	Vented
Crest stage gaging	TPU	Non-vented
Dewatering	TPU	Vented or non-vented
Flood and storm surge monitoring	TPU	Non-vented
Landfill monitoring	Tefzel	Non-vented
Municipal and industrial monitoring (SCADA)	TPU	Non-vented
Remediation projects	Tefzel	Vented
River, lake, and reservoir monitoring	TPU	Vented or non-vented
Saltwater/brackish water	TPU or Tefzel	Vented or non-vented
Stormwater monitoring	TPU	Vented or non-vented
Tide/harbor monitoring	TPU or Tefzel	Vented
Wetland and estuary monitoring	TPU or Tefzel	Vented or non-vented

Specifications are subject to change without notice.
This product may be covered by patents identified at www.in-situ.com/patents.

Accessories

- Large desiccant for low-humidity environments or for deployments where maintenance occurs frequently.
- Extra large desiccant for high-humidity environments or for deployments where maintenance occurs infrequently. Desiccates six times more saturated air than the large desiccant.
- Titanium cable extenders are used to join two lengths of cable without signal loss. The cable extender seals the cables, provides a weight-bearing connection, and maintains venting.
- Plastic and steel reels



Large desiccant with titanium twist-lock connector for standard deployments



Economical large plastic desiccant



Extra large desiccant with titanium twist-lock connector for high-humidity sites, remote sites, or applications that require fast sampling rates.



Outboard desiccant for use with stripped-and-tinned RuggedCable Systems



Titanium cable extender

Kellems is a registered trademark of Hubbell Incorporated.
Teflon and Tefzel are registered trademarks of E.I. Du Pont de Nemours and Co.



Level TROLL専用 裸線ケーブル(オス型Twist-Lockコネクタ付)

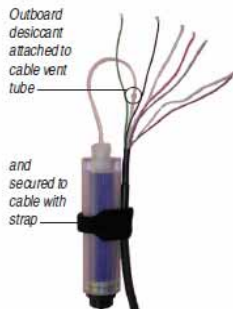
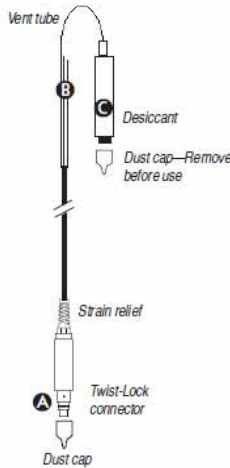

乾燥剤は、電線との接続作業によっては、通気ケーブルから外すこともあります。通気ケーブル延長管を引き抜いて、通気ケーブルを外してください。電線接続、端末処理後、乾燥剤の通気ケーブルを通気ケーブルに接続し、図のようにストラップで乾燥剤にケーブルを固定してください。

LevelTROLLを通信方法に応じて直接制御器やロガーに接続してください。

- ・アナログ(4-20mA)
- ・SDI-12
- ・RS485 Modbus
- ・RS232 Modbus(コンバーターが必要です)

- Ⓐ Ruggedケーブル側のメスのツイストロック コネクターにあうオスのツイストロック コネク
- Ⓑ PLCやロガーとの配線と反対側のStripped&Tinnedワイヤー
- Ⓒ 高い湿度環境からベントチューブを守るための取り外し可能な外付けの乾燥剤。

仕様

材質	PVC、チタン、ナイロン、バイトン
寸法	長さ13.33cm(Strain reliefを含む) 直径19mm
耐環境性	接続時はIP67、水没には未対応
ケーブル	長さ0.9m 通気ケーブルのある耐熱性ポリウレタン
電線	6芯ケーブル、24AWG、絶縁ポリプロピレン
乾燥剤パック	透明アクリル樹脂、HDPEメンブレン
乾燥剤	約22グラム、シリカゲル、タイプ4
最大ケーブル長さ	SDI-12 61m MODBUS 1259m

接続方法

・この書類の裏面の配線図を参照してください。使用しない電線は、絶縁処理をしてください。シールド線は、筐体アースもしくはグラウンドに接続してください。

電源接続

赤色はModbusやSDI-12モードの場合の電源を供給します。茶色は4-20mAモードの場合の電源を供給します。もし、茶色に電源がきており、赤色に無い場合は、LevelTROLLは自動的に4-20mAモードになり、茶色から電源がなくなるまで、もしくは赤線に電源が供給されない限り4-20mAモードのままです。赤線は、優先されます。仮に電源を同時に両方の線に供給した場合は、LevelTROLLは、4-20mAモードではなく、ModbusもしくはSDI-12モードで動作します。

通信

LevelTROLLは自動的に、2つのインターフェイスのどちらが動作しているかにより、ModbusとSDI-12の間で自動的に切り替えます。ModbusとSDI-12は、同時に使用することはできません。いずれかが使用されていると、一方の通信を妨げます。

・Win-Situ5ソフトを使用してシリアルCOMポートでTROLL9500と通信するためには、短い裸線ケーブルのコネクターからRuggedケーブルを取り外してください。RuggedケーブルにTROLL COMを取りつけてください。WinSitu5が動作するPCのシリアルポートにTROLL COMのDB9ピンコネクターを接続してください。

SHORT STRIPPED & TINNED CABLE

Level TROLL Connections

ANALOG (4-20 mA) 2 WIRE

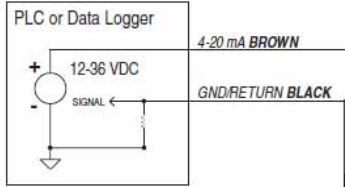

SDI-12 3 WIRE

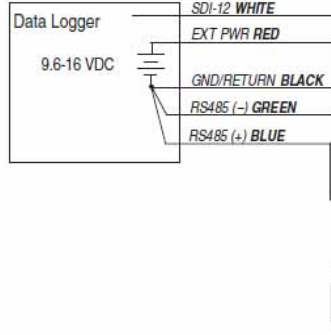

MODBUS MASTER with RS485 built in

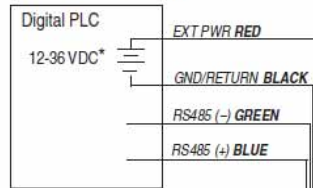

* Optional but highly recommended

MODBUS MASTER with RS232 built in (converter required)

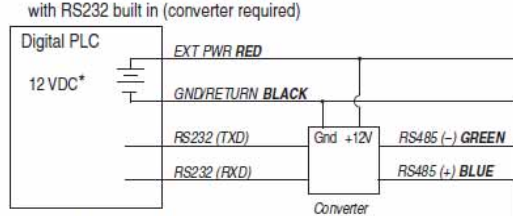

* Voltage limited by converter

CONVERTER

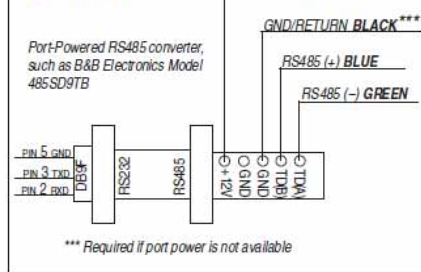

*** Required if port power is not available

Signal	Color
Gnd/Return	BLACK
Ext Power	RED
4-20 mA	BROWN
RS485(-)	GREEN
RS485(+)	BLUE
SDI-12	WHITE

1 800 446 7488
(toll-free, US and Canada) or 970 498 1500 www.in-situ.com



Due to continuing product development this information is subject to change without notice. In-Situ and the In-Situ logo, Win-Situ, TROLL, BaroTROLL, RuggedReader, RuggedCable and RDC are trademarks or registered trademarks of In-Situ Inc. Viton is a registered trademark of DuPont Dow Elastomers. Copyright © 2005-2007 by In-Situ Inc. All rights reserved.

0053312 rev. 004 09/07